

Wetroom Floors



Product Guide

marmox
showerlay
 Floor level shower base

marmox
decotray
 Floor level shower tray

marmox
minilay
 Point & Linear Drain Kits



At Marmox we supply a range of products for waterproofing & insulating.

Well known for the Marmox Multiboards, used to coat floors and walls and then tiled, plastered or rendered, we also supply a range of wetroom floor solutions that can work hand in hand with Multiboards to create a complete wetroom.

It's easier than ever to create a sloping wetroom floor, ready for tiling. Several options are available to meet different needs, including various size floor formers and drainage systems, which make it easy to create a bespoke floor slope.

Why use Marmox Wetroom Floor Products?



FULLY WATERPROOF

All of our wetroom floor systems allow for a completely waterproof wetroom or bathroom floor. Various accessories are available for further waterproofing.



LIGHTWEIGHT & EASY TO CUT

Marmox Showerlays are polystyrene (XPS) based and offer a very lightweight, trimable solution which is easy to cut with a saw and clean to handle.



EFFECTIVE DECOUPLING

The combination of the rigid outer shell and the XPS core, which absorbs lateral movement, makes for an effective decoupling layer.



MARMOX LIFETIME GUARANTEE

Marmox product range comes with a Lifetime Guarantee for total peace of mind.

Marmox Wetroom Floors

There are 5 different drainage options in the Marmox UK range. This includes both linear and square drain options.



Linear Drain
Pre-formed slope



Key Benefits

- Pre-formed fall ready to receive tiles
- Lightweight
- Quick & easy to install
- Waterproof fleece

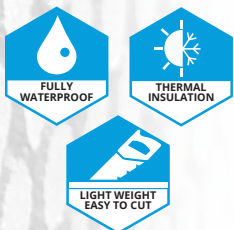

Linear style floor level shower base

Showerlay Linears are constructed from high density polystyrene, extruded to the precise shape and dimensions required to ensure a suitable flow rate to the in-built drain. Marmox foam is coated on both sides with a fibreglass mesh embedded in a unique blend of Marmox cement polymer mortar, then topped with a waterproof fleece. The fleece overlaps by 100mm, which can be adhered down to joining substrate, creating a waterproof joint & peace of mind.

Linears are 40mm thick on the perimeter with a stylish brushed stainless steel linear channel grate. They feature a height adjustable drain grate to match the height of thicker tiles when necessary.

Find out more, including fitting instructions at:
www.marmox.co.uk

Sizes

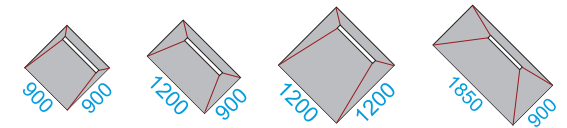

Drain Parts

Choose your grate
Tileable, Circles or Lines

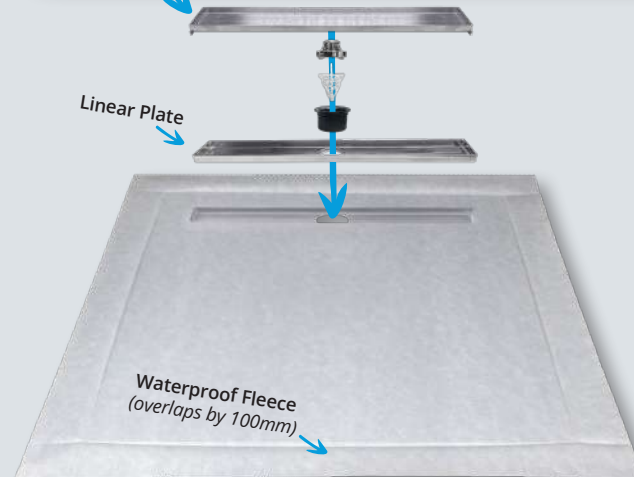
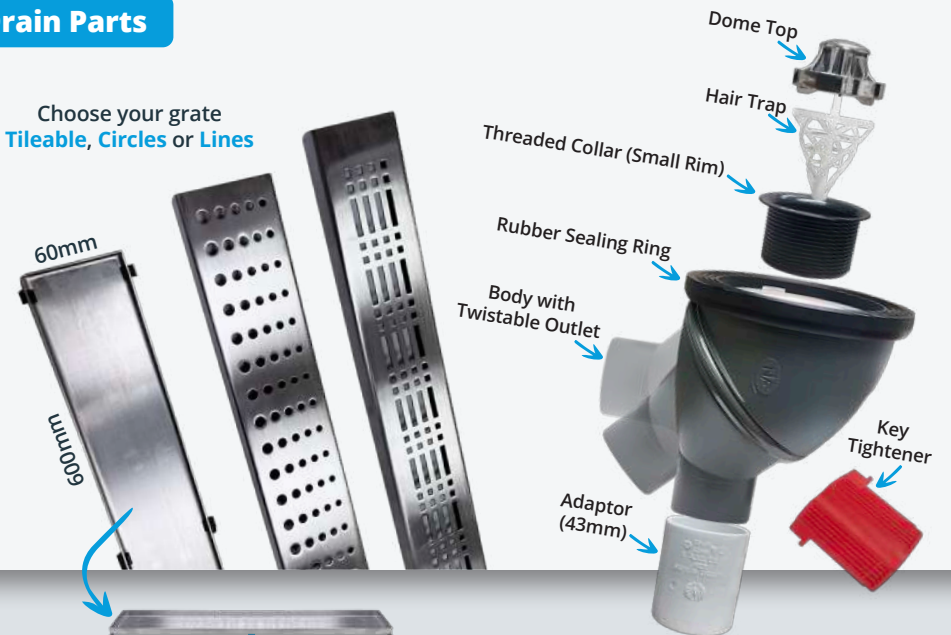

Drain Height (mm)



Data	
Product	Performance Litres per min
360°	30

Square Drain
Pre-formed slope



Key Benefits

- Pre-formed fall ready to receive tiles
- Lightweight
- Quick & easy to install
- Waterproof fleece

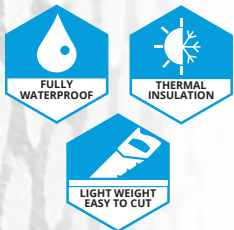

Square drain style floor level shower base

Showerlays are constructed from high density polystyrene, extruded to the precise shape and dimensions required to ensure a suitable flow rate to the in-built drain. Marmox foam is coated on both sides with a fibreglass mesh embedded in a unique blend of Marmox cement polymer mortar, then topped with a waterproof fleece. The fleece overlaps by 100mm, which can be adhered down to joining substrate, creating a waterproof joint & peace of mind.

Showerlays are 20-24mm thick on the perimeter (depending on size) with a brushed stainless steel grate in various locations. They feature a height adjustable drain grate.

Find out more, including fitting instructions at:
www.marmox.co.uk

Sizes

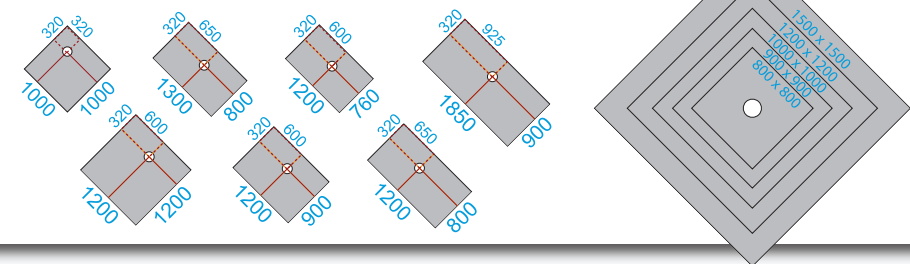

Drain Parts

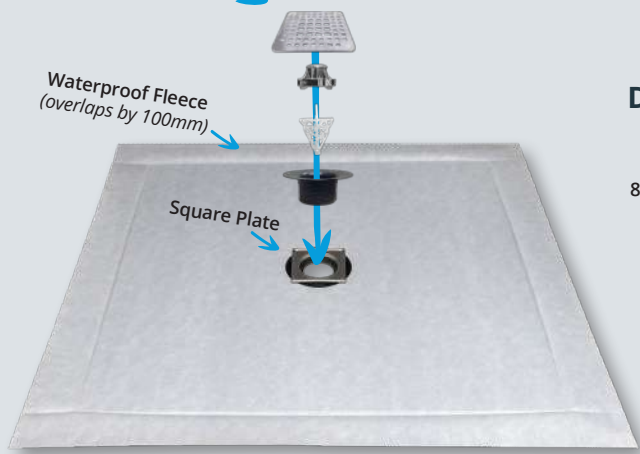

Drain Height (mm)



Data	
Product	Performance
360°	Litres per min
	30

Wetroom Tray
Pre-formed slope

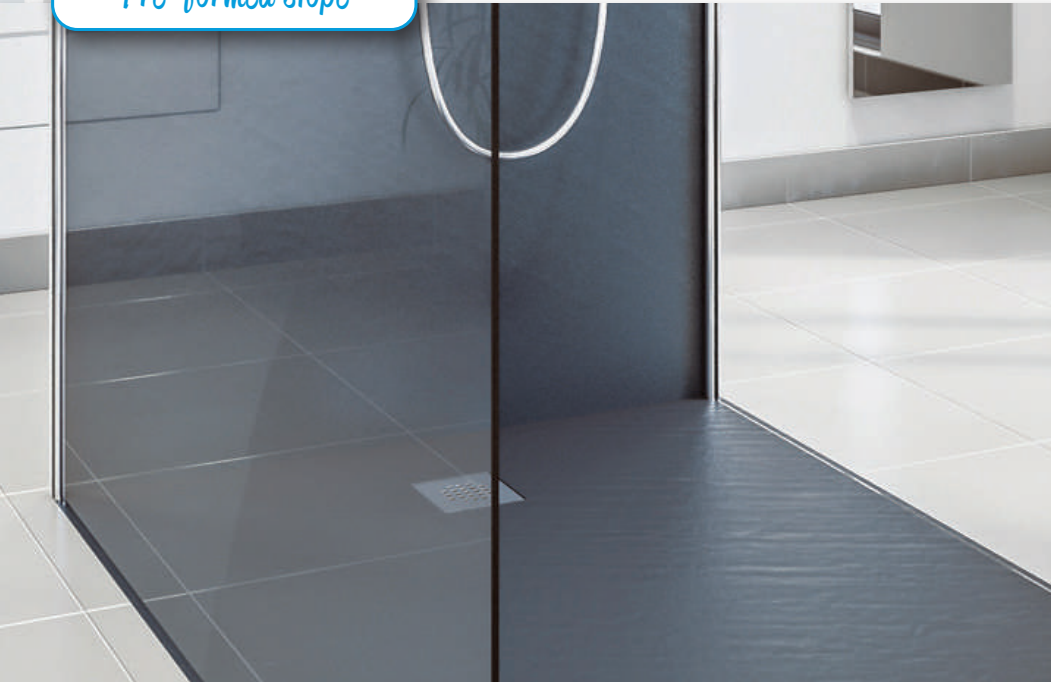

Key Benefits

- Stylish design finish
- Pre-formed slope
- Fully waterproof
- Centre or offset drain



Stone effect, pre-formed, resin shower floor former

The Decotray is an excellent choice for designing a stylish, sloping floor with a visually appealing aesthetic and a high-quality finish. It is crafted from Marmoxite, a patented resin-bound synthetic stone.

The design ensures that it not only looks stunning but also provides a functional and long-lasting solution for wetroom floors. Whether you prefer the sleek, modern look of Slate Grey or the crisp, clean appearance of Polar White, the Decotray delivers a premium finish that enhances any space.

Find out more, including fitting instructions at:
www.marmox.co.uk

Sizes

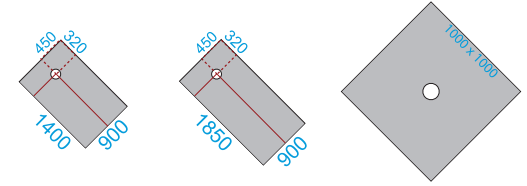

Drain Parts

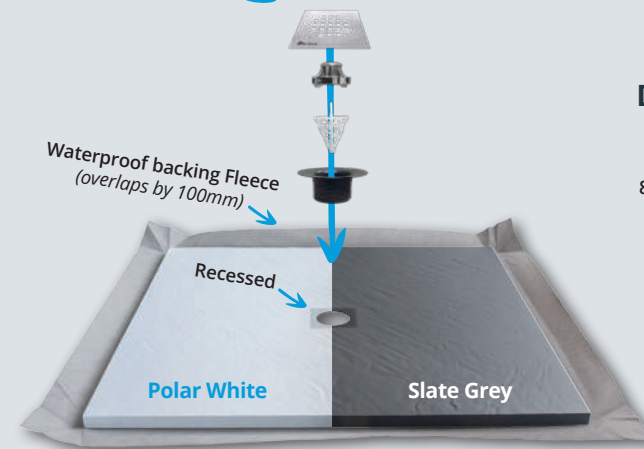
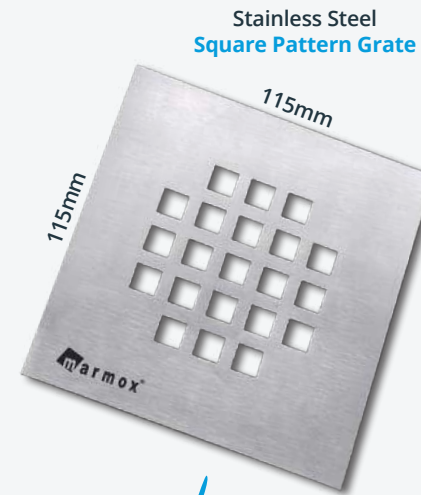

Drain Height (mm)



Data	
Product	Performance
360°	Litres per min
	30

Linear Drain
Create your own slope

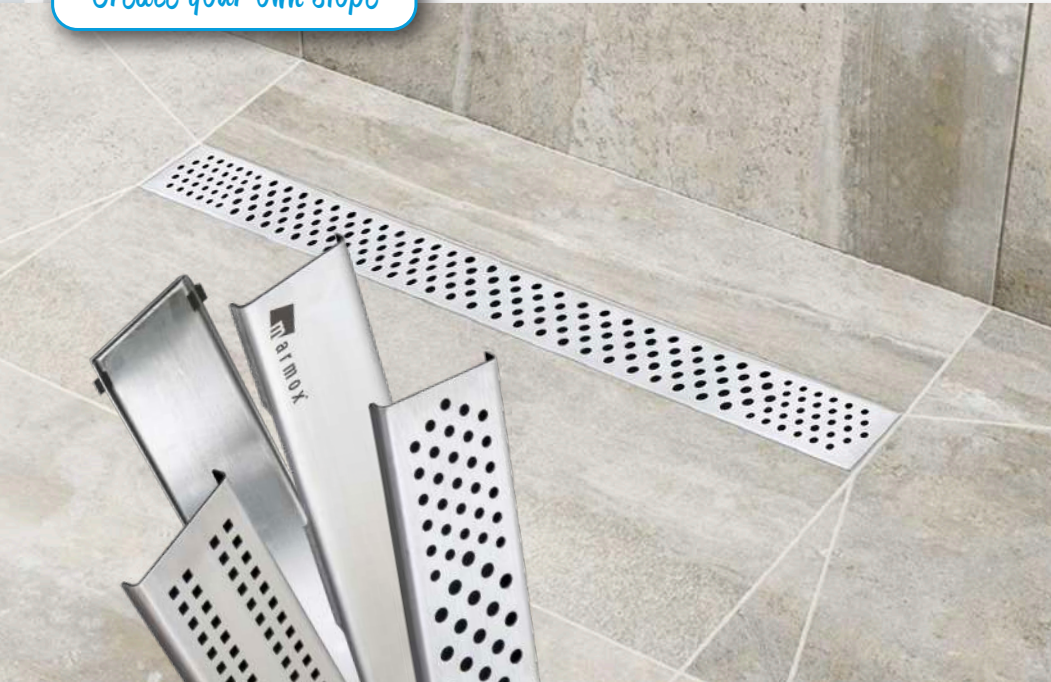

Key Benefits

- Create bespoke slope
- Square or linear drain
- Slimline or 360° waste
- Various grate options



Create your own shower slope

Minilay provides the flexibility and freedom to transform any concrete floor into a tileable wetroom floor.

Marmox Minilay is a drainage gully which has been factory fitted into a height adjustable frame, which itself sits within a small rigid board. This small board provides a solid surface immediately around the drain from which the slope of the shower floor can be continued with the screed.

Available with a twistable 360° or a slimline waste, in Linear and Square drain options.

Find out more, including fitting instructions at:
www.marmox.co.uk

Drain Kit



Drain Parts

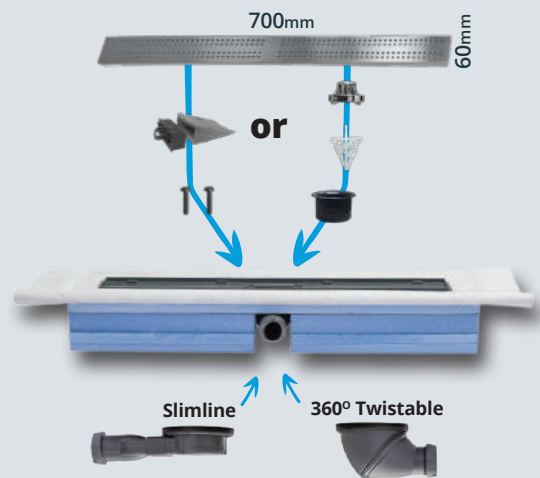
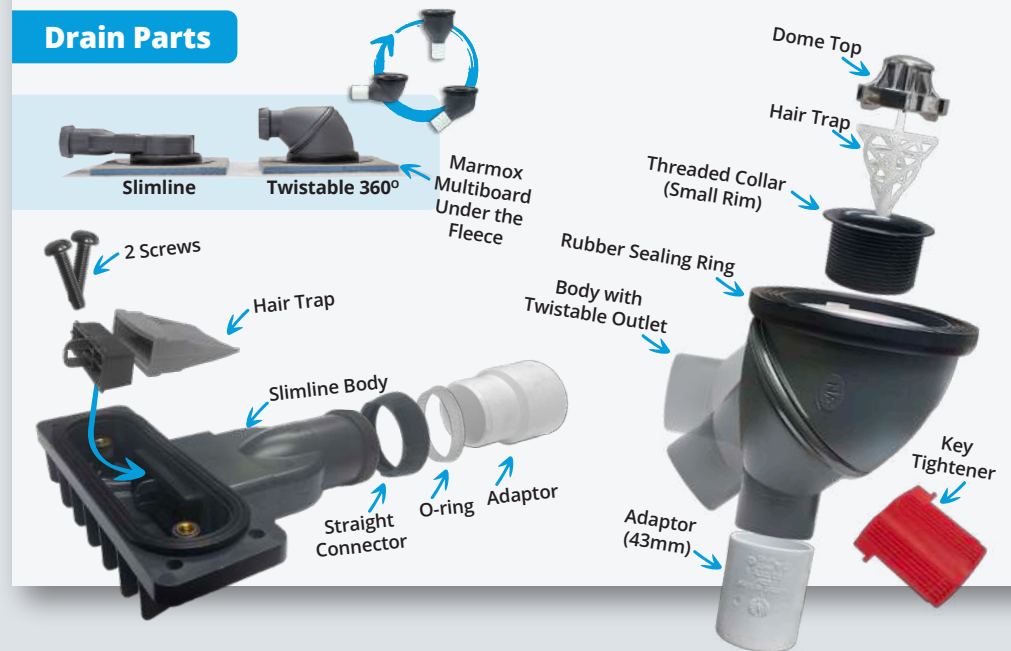

Drain Height (mm)



Sizes & Data

Product	Connection (mm)	Performance Litres per min
360°	43	30
Slimline	50	33.6

Square Drain
Create your own slope

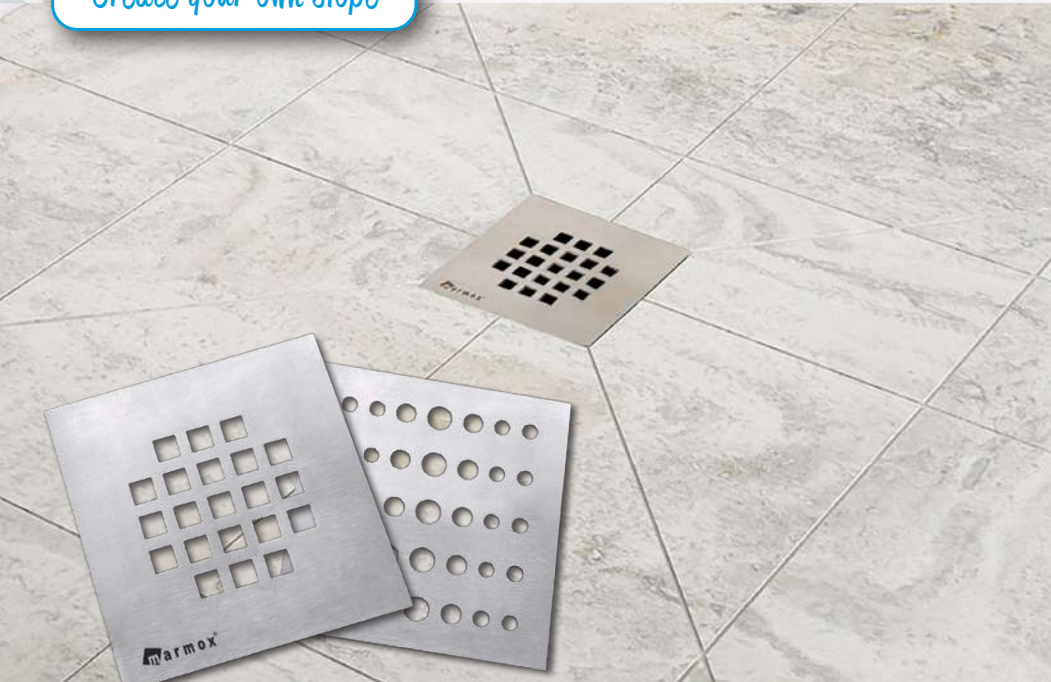

Key Benefits

- Create bespoke slope
- Square or linear drain
- Slimline or 360° waste
- Various grate options



Create your own shower slope

Minilay provides the flexibility and freedom to transform any concrete floor into a tileable wetroom floor.

Marmox Minilay is a drainage gully which has been factory fitted into a height adjustable frame which itself sits within a small rigid board. This small board provides a solid surface immediately around the drain from which the slope of the shower floor can be continued with the screed.

Available with a twistable 360° or a slimline waste, in Linear and Square drain options.

Find out more, including fitting instructions at:
www.marmox.co.uk



Drain Parts

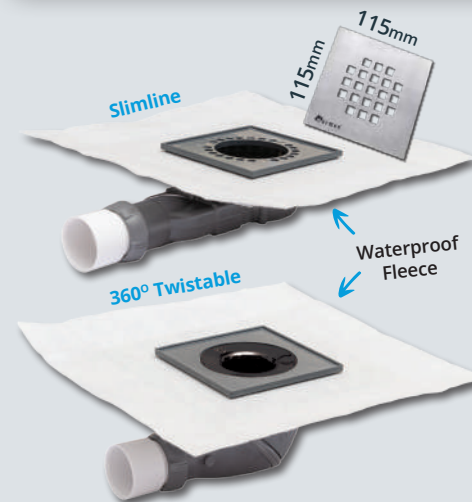
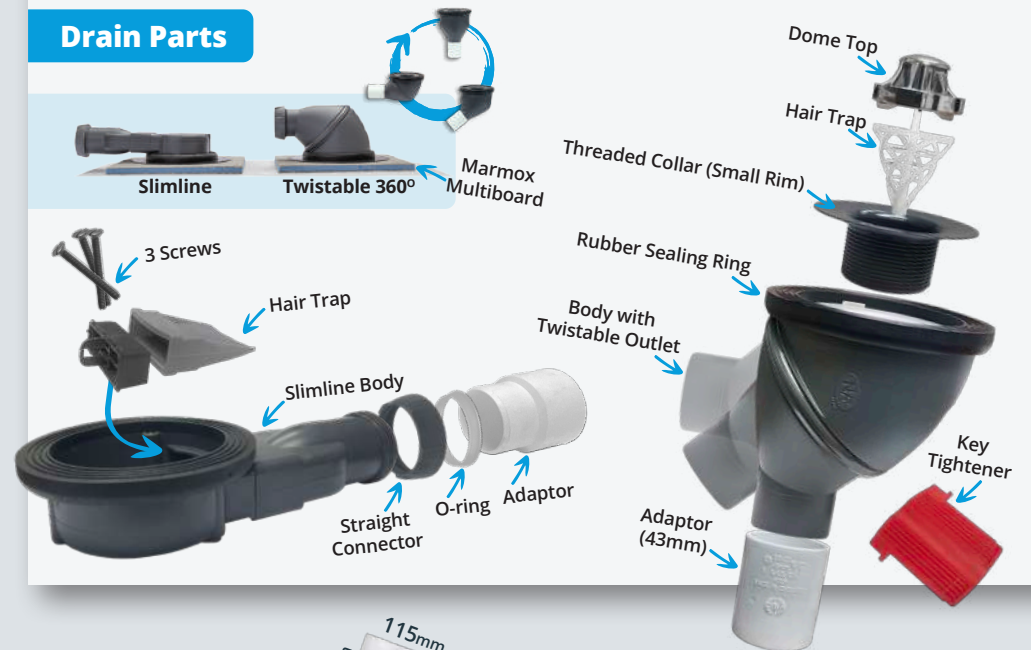

Drain Height (mm)



Sizes & Data

Product	Connection (mm)	Performance Litres per min
360°	43	30
Slimline	50	33.6

Accessories

Marmox MSP360:

Premium Adhesive and Sealant. Ultra high performance, professional, heavy duty. Fully waterproof - it even cures under water!



Marmox Waterproof Fleece:

Fully waterproof fleece for tanking wet areas. For use with or without Multiboard.



Marmox S/A Waterproof Tape:

10 metre roll of the popular Marmox tanking tape for use with Marmox Multiboards in all wet areas.



Marmox Waterproof Corners:

Use these pre-formed fleece corners for easy waterproof protection. Available for Internal and external corners.



Marmox Washers: Available in buckets (500) or bags (100), in metal or plastic. **Note:** plastic washers only available by the bag.



marmox multiboard

Waterproofing • Insulating • Drylining

The tried and trusted construction material which merges water proofing, insulation and structural strength into a reliable, BBA certified board. Lightweight and easy to cut with minimal dust, it accommodates tiling, plastering, and rendering, both indoors and outdoors.

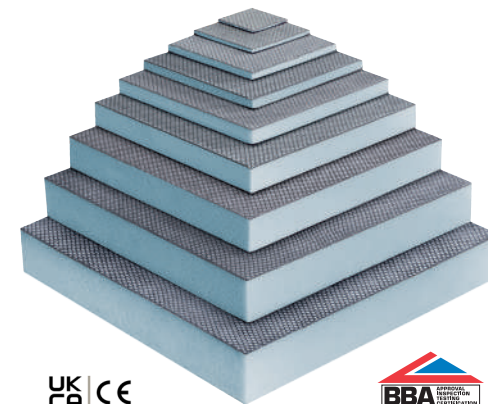

UK
CA CE



Tile it • Plaster it • Render it

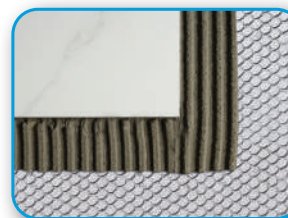

Tiles - Ultimate substrate for tiles. Hold up to 100kg/m²



Plaster - No need to PVA, plaster directly onto them

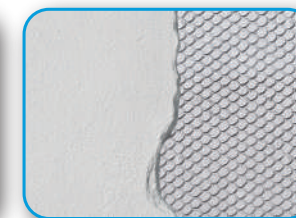

Render - Will support many different types of render

Also See the Marmox Multiboard Product & Installation Guide



www.marmox.co.uk

**Always look out for the
honeycomb finish**

*It means... Genuine Marmox and an
ultra-strong surface for adhesion!*

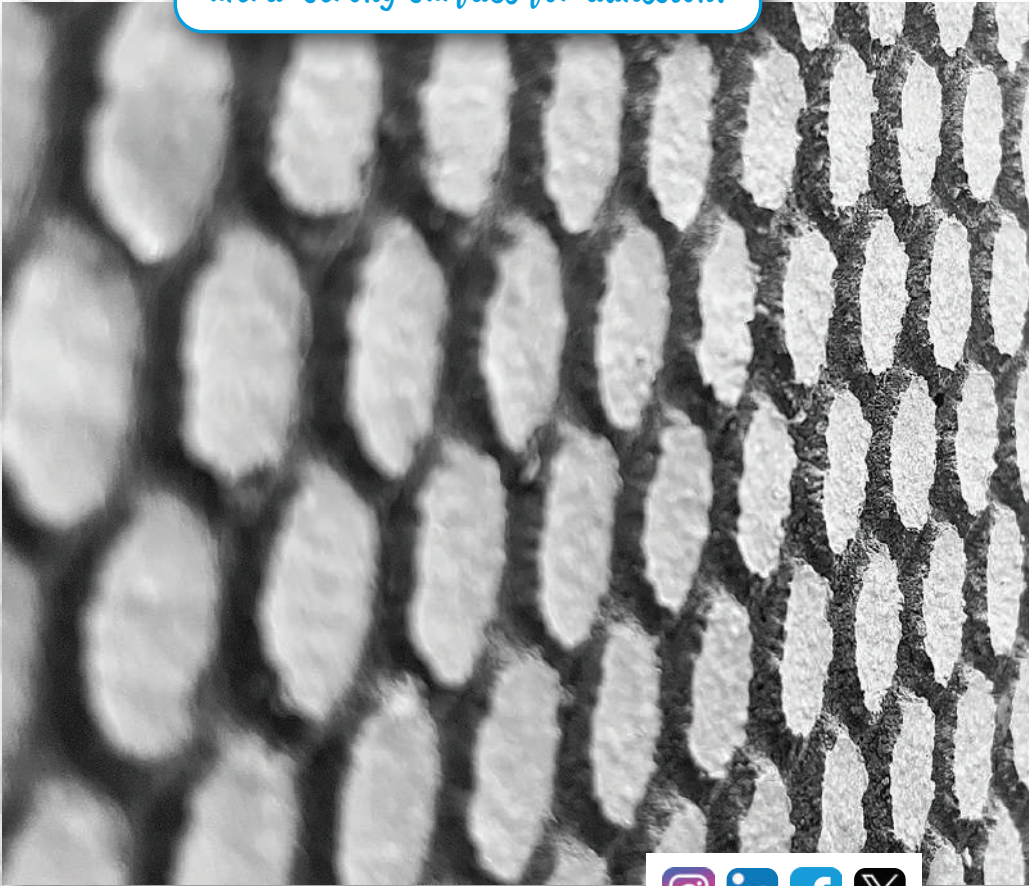

Marmox UK Ltd

Caxton House,
101-103 Hopewell Drive,
Chatham, Kent. ME5 7NP
United Kingdom

For information and advice:

Tel: 01634 835290
Email: sales@marmox.co.uk
Web: www.marmox.co.uk

